

DALLAS
SEMICONDUCTOR

UniqueWare™ **DS2502/5/6-UNW**
Add-Only Memory

SPECIAL FEATURES

- 1024 bits, 16K bits or 64K bits Electrically Programmable Read Only Memory (EPROM) communicates with the economy of one signal plus ground
- Unique, factory-lasered and tested 64-bit registration number (8-bit family code, 36-bit serialization, 12-bit UniqueWare Identifier 5E7H, 8-bit CRC-tester) assures absolute traceability because no two parts are alike.
- Built-in multidrop controller ensures compatibility with other MicroLAN products
- EPROM partitioned into two 256-bit pages for randomly accessing packetized data records
- Each memory page can be permanently write-protected to prevent tampering
- Device is an "add only" memory where additional data can be programmed into EPROM without disturbing existing data
- Reduces control, address, data, power and programming signals to a single pin
- Directly connects to a single port pin of a microprocessor and communicates at up to 16.3k bits per second
- Presence detector acknowledges when reader first applies voltage
- Low cost TO-92/PR-35 or 8-pin SOIC and TSOC surface mount packages
- Reads over a wide voltage range of 2.8V to 6.0V from -40°C to +85°C

SILICON LABEL DESCRIPTION

UniqueWare Add-Only Memories are factory programmed versions of the DS2502 (1024 bit), the DS2505 (16K bit) and the DS2506 (64K bit) Add-Only Memories, respectively. They differ from the regular devices in their custom ROM family codes (see Ordering Information) and the UniqueWare Identifier 5E7 in place of the upper 12 bits of the standard serialization field. For technical details on the devices please refer to the DS2502, DS2505 and DS2506 data sheets.

UniqueWare Add-Only Memories are only available preprogrammed with customer-specific and write-protected data. UniqueWare data fills at least one but no

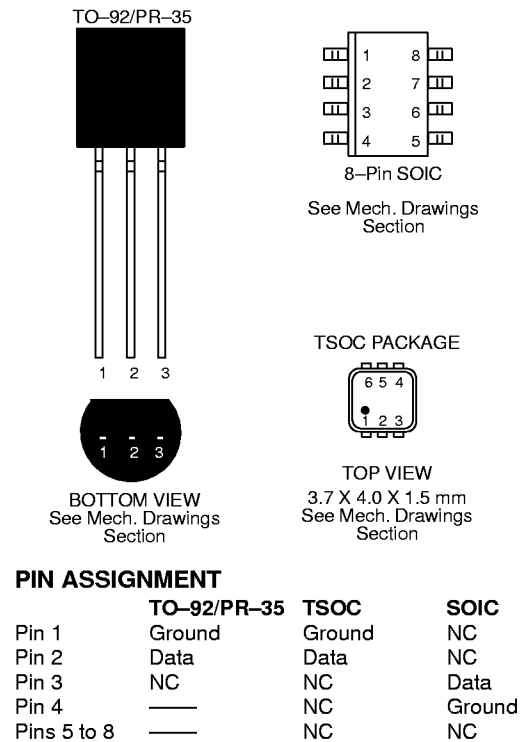

more than the first four pages of a device, depending on the length of the customer-supplied data. This leaves up to three (DS2502-UNW), 63 (DS2505-UNW) or 255 (DS2506-UNW) memory pages available for programming in the application.

For more details on UniqueWare and how to set up data files, please refer to the UniqueWare Project Setup Manual, available as Application Note 99 from Dallas Semiconductor. The UniqueWare Project Setup Software is available from the Dallas Semiconductor FTP Site at ftp://ftp.dalsemi.com/pub/auto_id_unwsetup.exe.

ORDERING INFORMATION

Memory Size	Family Code	Package	Ordering Part Number
1024 bits (4 pages)	89h	TO-92 package 8-pin 150 mil SOIC pkg. 6-pin TSOC package	DS2502-UNW-pppp DS2502S-UNW-pppp DS2502P-UNW-pppp
16K bits (64 pages)	8Bh	TO-92 package 6-pin TSOC package	DS2505-UNW-pppp DS2505P-UNW-pppp
64K bits (256 pages)	8Fh	PR-35 package 8-pin 208 mil SOIC pkg.	DS2506-UNW-pppp DS2506S-UNW-pppp

pppp stands for the Project ID assigned to each individual data pattern at the time of the first order.

Sample UniqueWare Data Structures**SAMPLE 1: ETHERNET NODE ADDRESS** Figure 1a

(unused)	CRC16		Company ID Value		Extension ID Value		Project ID		Length
	MSB	LSB	MSB	LSB	MSB	LSB	MSB	LSB	
19 bytes FFH	2 bytes		3 bytes constant assigned by IEEE		3 bytes serialization		4 bytes constant		1 byte 0AH

high address low address

PHYSICAL ADDRESS AND DATA MAPPING Figure 1b

ADDRESS	0C	0B	0A	09	08	07	06	05	04	03	02	01	00
DATA	xx	xx	ch	cm	cl	hh	mm	ll	00	00	pp	pp	0A

xx xx = CRC16, value depends on actual data

ch cm cl = high, medium and low byte of the IEEE assigned "Company ID"

hh mm ll = high, medium and low byte of the "Extension ID" or serialization

pp pp = Project ID assigned by Dallas Semiconductor

SAMPLE 2: EUI-64 FireWire™ NODE ADDRESS Figure 2a

(unused)	CRC16		Company ID Value		Extension ID Value		Project ID		Length
	MSB	LSB	MSB	LSB	MSB	LSB	MSB	LSB	
17 bytes FFH	2 bytes		3 bytes constant assigned by IEEE		5 bytes serialization		4 bytes constant		1 byte 0CH

high address low address

PHYSICAL ADDRESS AND DATA MAPPING Figure 2b

ADDRESS	0E	0D	0C	0B	0A	09	08	07	06	05	04	03	02	01	00
DATA	xx	xx	ch	cm	cl	hh	hm	mm	ml	ll	00	00	pp	pp	0C

xx xx = CRC16, value depends on actual data

ch cm cl = high, medium and low byte of the IEEE assigned "Company ID"

hh hm mm ml ll = high, medium and low byte of the "Extension ID" or serialization

pp pp = Project ID assigned by Dallas Semiconductor

FireWire™ is a trademark of Apple Computer, Inc.

MECHANICAL DRAWINGS

8-, 14-, AND 16-PIN SOIC (.150" BODY WIDTH)

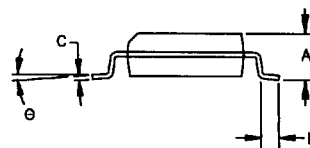
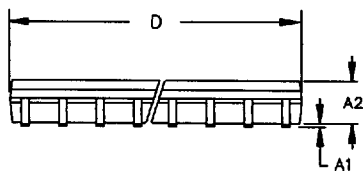
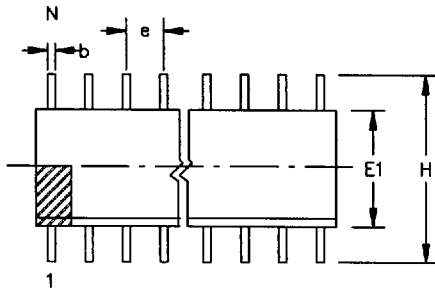

PKG	8-PIN		14-PIN		16-PIN	
	MIN	MAX	MIN	MAX	MIN	MAX
A IN. MM	0.053 1.35	0.069 1.75	0.053 1.35	0.069 1.75	0.053 1.35	0.069 1.75
A1 IN. MM	0.004 0.10	0.010 0.25	0.004 0.10	0.010 0.25	0.004 0.10	0.010 0.25
A2 IN. MM	0.048 1.24	0.062 1.57	0.048 1.24	0.062 1.57	0.048 1.24	0.062 1.57
b IN. MM	0.012 0.30	0.020 0.50	0.012 0.30	0.020 0.50	0.012 0.30	0.020 0.50
C IN. MM	0.007 0.17	0.011 0.28	0.007 0.17	0.011 0.28	0.007 0.17	0.011 0.28
D IN. MM	0.188 4.78	0.196 4.98	0.337 8.55	0.344 8.74	0.386 9.80	0.393 9.98
e IN. MM	0.050 BSC 1.27 BSC		0.050 BSC 1.27 BSC		0.050 BSC 1.27 BSC	
E1 IN. MM	0.150 3.81	0.158 4.01	0.150 3.81	0.158 4.01	0.150 3.81	0.158 4.01
H IN. MM	0.230 5.84	0.244 6.20	0.230 5.84	0.244 6.20	0.230 5.84	0.244 6.20
L IN. MM	0.016 0.40	0.050 0.89	0.016 0.40	0.050 0.89	0.016 0.40	0.050 0.89
θ	0°	8°	0°	8°	0°	8°

8-PIN SOIC (208 MIL)

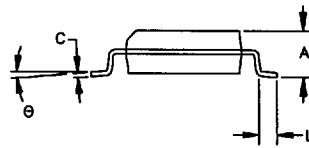
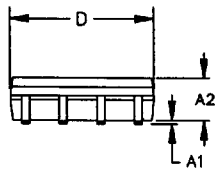
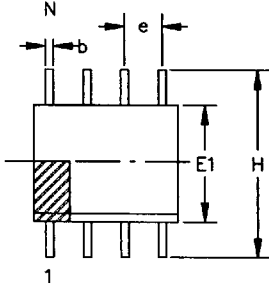

208 Mil
Includes:
DS1202
DS1302
DS1602S
DS1620
DS1625S
DS1651S
DS1652S
DS1669S
DS1821S
DS2404

PKG	8-PIN	
DIM	MIN	MAX
A IN. MM	0.072 1.83	0.084 2.13
A1 IN. MM	0.004 0.102	0.010 0.25
A2 IN. MM	0.070 1.78	0.080 2.03
b IN. MM	0.013 0.33	0.020 0.51
C IN. MM	0.006 0.15	0.010 0.25
D IN. MM	0.203 5.16	0.215 5.46
e IN MM	0.050 BSC 1.27 BSC	
E1 IN MM	0.203 5.16	0.213 5.41
H IN. MM	0.302 7.67	0.318 8.07
L IN. MM	0.019 0.48	0.030 0.76
θ	0°	8°

PR35 PACKAGE

Includes:
DS1820
DS2506

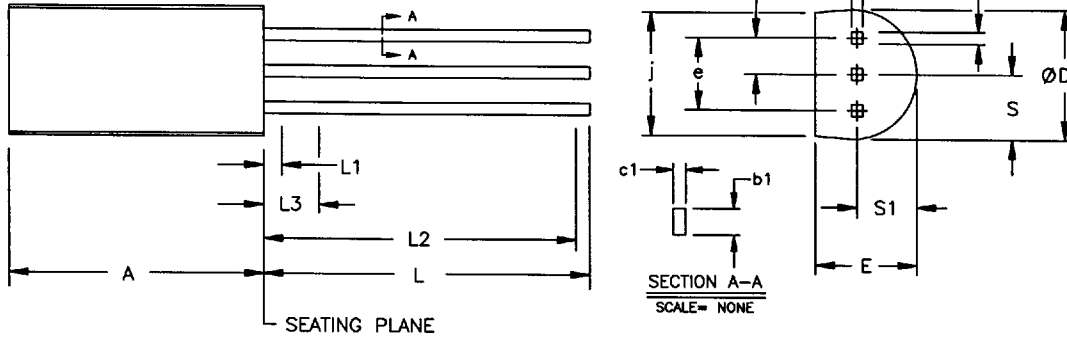

PKG	PR35			
DIM	MIN	TYP	MAX	NOTE
A IN. MM	0.348 8.84	0.350 8.89	0.353 8.97	
b IN. MM	0.015 0.38	-	0.022 0.56	
b1 IN. MM	0.015 0.38	-	0.018 0.46	2
c IN. MM	0.014 0.36	-	0.020 0.51	
c1 IN. MM	0.014 0.36	-	0.016 0.41	2
D IN. MM	0.178 4.52	0.180 4.57	0.183 4.65	
E IN. MM	0.135 3.43	0.140 3.56	0.145 3.68	
e IN. MM	0.095 2.41	0.100 2.54	0.105 2.67	
e1 IN. MM	0.045 1.14	0.050 1.27	0.055 1.40	
J IN. MM	0.180 4.06	-	-	4
L IN. MM	0.420 10.67	-	-	
L1 IN. MM	-	-	0.050 1.27	1
L2 IN. MM	0.250 6.35	-	-	2
L3 IN. MM	-	-	0.100 2.54	2
S IN. MM	0.083 2.11	0.090 2.29	0.099 2.51	3
S1 IN. MM	0.080 2.03	0.0825 2.10	0.090 2.29	3

NOTES:

1. TERMINAL DIMENSIONS ARE UNCONTROLLED WITHIN L1.
2. b1 AND c1 APPLY BETWEEN L3 AND L2.
3. S DIMENSION IS DISTANCE FROM TRUE POSITION CENTERLINE OF THE MIDDLE LEAD POSITION TO THE EXTREMITY OF THE BODY.
4. FLAT INDEX SURFACE FOR MARKING.

MECHANICAL DRAWINGS

TO-92 PACKAGE

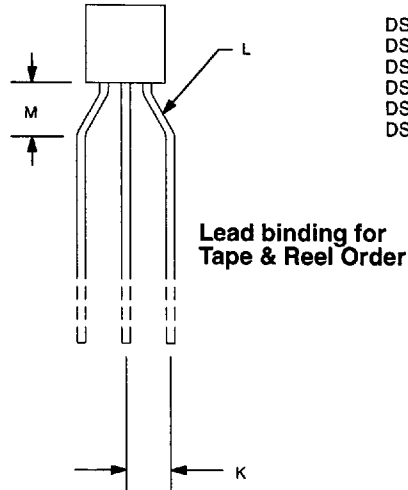
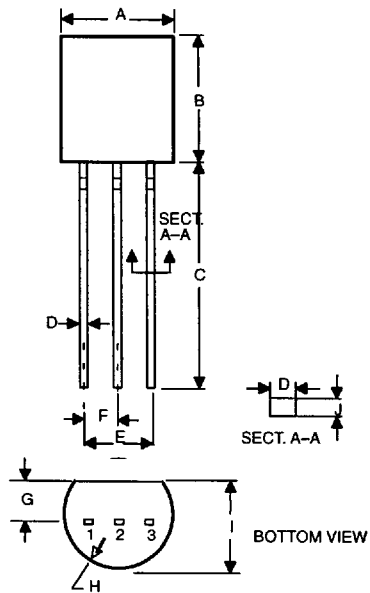

Includes:

- DS1233
- DS1233A
- DS1233D
- DS1833
- DS2223
- DS2224
- DS2401
- DS2405
- DS2430
- DS2502
- DS2505

**Lead binding for
Tape & Reel Order**

PKG	TO-92	
DIM	MIN	MAX
A IN. MM	0.175 4.45	0.195 4.96
B IN. MM	0.170 4.32	0.195 4.96
C IN. MM	0.500 12.70	0.610 15.49
D IN. MM	0.016 0.406	0.022 0.559
E IN. MM	0.095 2.41	0.105 2.67
F IN. MM	0.045 1.14	0.060 1.52
G IN. MM	0.45 1.14	0.060 1.52
H IN. MM	0.085 2.16	0.095 2.41
I IN. MM	0.130 3.30	0.155 3.94
J IN. MM	0.014 0.35	0.020 0.51
K IN. MM	0.093 2.36	0.115 2.92
L IN. MM	45°	60°
M IN. MM	0.118 TYPICAL 3.00	

6-PIN TSOC (C-LEAD)

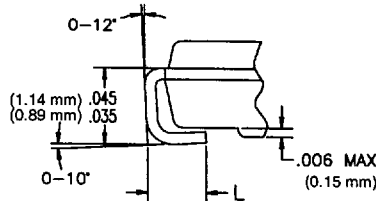
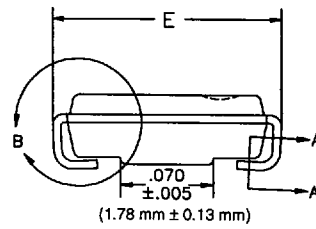
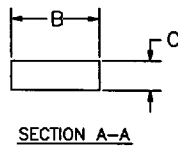
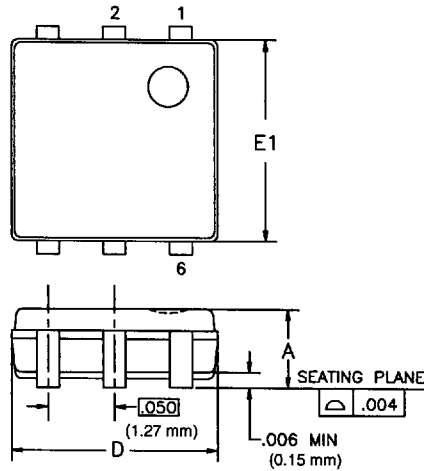

- Includes:**
 DS2401
 DS2405
 DS2407
 DS2430A
 DS2501-UNW
 DS2502
 DS2502-UNW
 DS2505

NOTES:

1. CONTROLLING DIMENSIONS: INCHES.
2. DIMENSIONS D AND E1 ARE MEASURED AT THE PARTING LINE AND DO NOT INCLUDE FLASH AND PROTRUSIONS; FLASH AND PROTRUSIONS NOT TO EXCEED .008 (0.20 mm) PER SIDE ON DIM. D AND .011 (0.28 mm) PER SIDE ON DIM. E1.
3. EXCLUSIVE OF DAMBAR PROTRUSION AND INTRUSION; DAMBAR PROTRUSION AND INTRUSION NOT TO BE POSITIONED ON FOOT OR LOWER RADIUS OF LEAD.

PKG	6-PIN C-LEAD (TSOC)			
DIM	MIN	NOM	MAX	NOTE
A IN. MM	0.051 1.30	0.055 1.40	0.059 1.50	
B IN. MM	0.016 0.41	0.017 0.43	0.019 0.48	3
C IN. MM	0.005 0.13	0.006 0.15	0.008 0.20	
D IN. MM	0.153 3.89	0.155 3.94	0.157 3.99	2
E IN. MM	0.163 4.14	0.169 4.29	0.175 4.45	
E1 IN. MM	0.144 3.66	0.150 3.81	0.152 3.86	2
L IN. MM	0.025 0.64	0.032 0.81	0.039 0.99	