

CASSETTE RECEIVER

KRC-705/759R/R/RY/785/805/  
859C/CY/R/R/RY/W/WY  
/885W/PS955

# KENWOOD

## SERVICE MANUAL

© 1998-2 PRINTED IN JAPAN  
B51-7309-00(B) 3299

Extension cord	Parts No.
cassette mechism (7P)	W05-0477-00
cassette mechism (10P)	W05-0609-00

### KRC-PS955

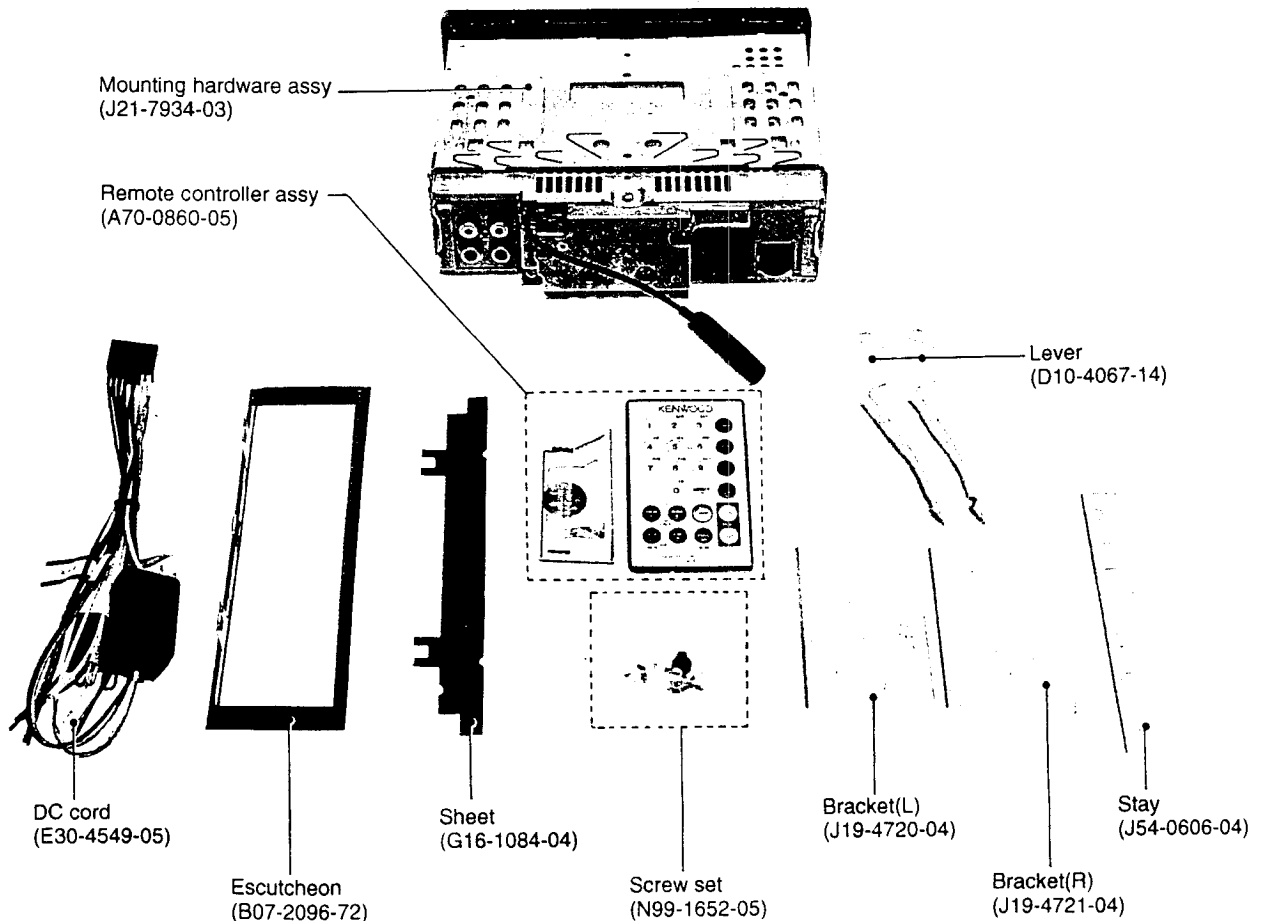
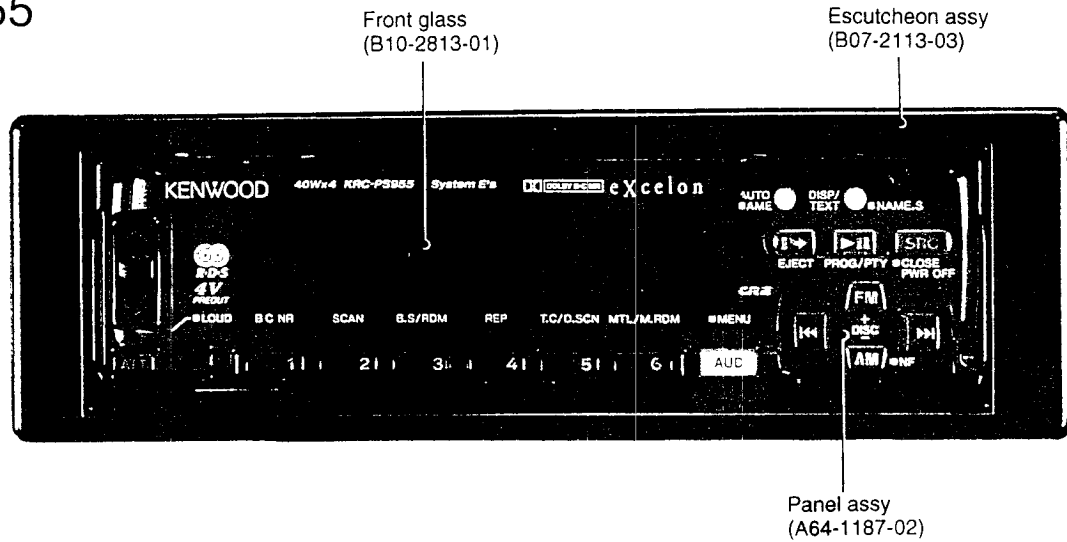

# KRC-705/759R/RV/785/805/859C /CY/R/RV/W/WY/885W/PS955

## BLOCK DIAGRAM

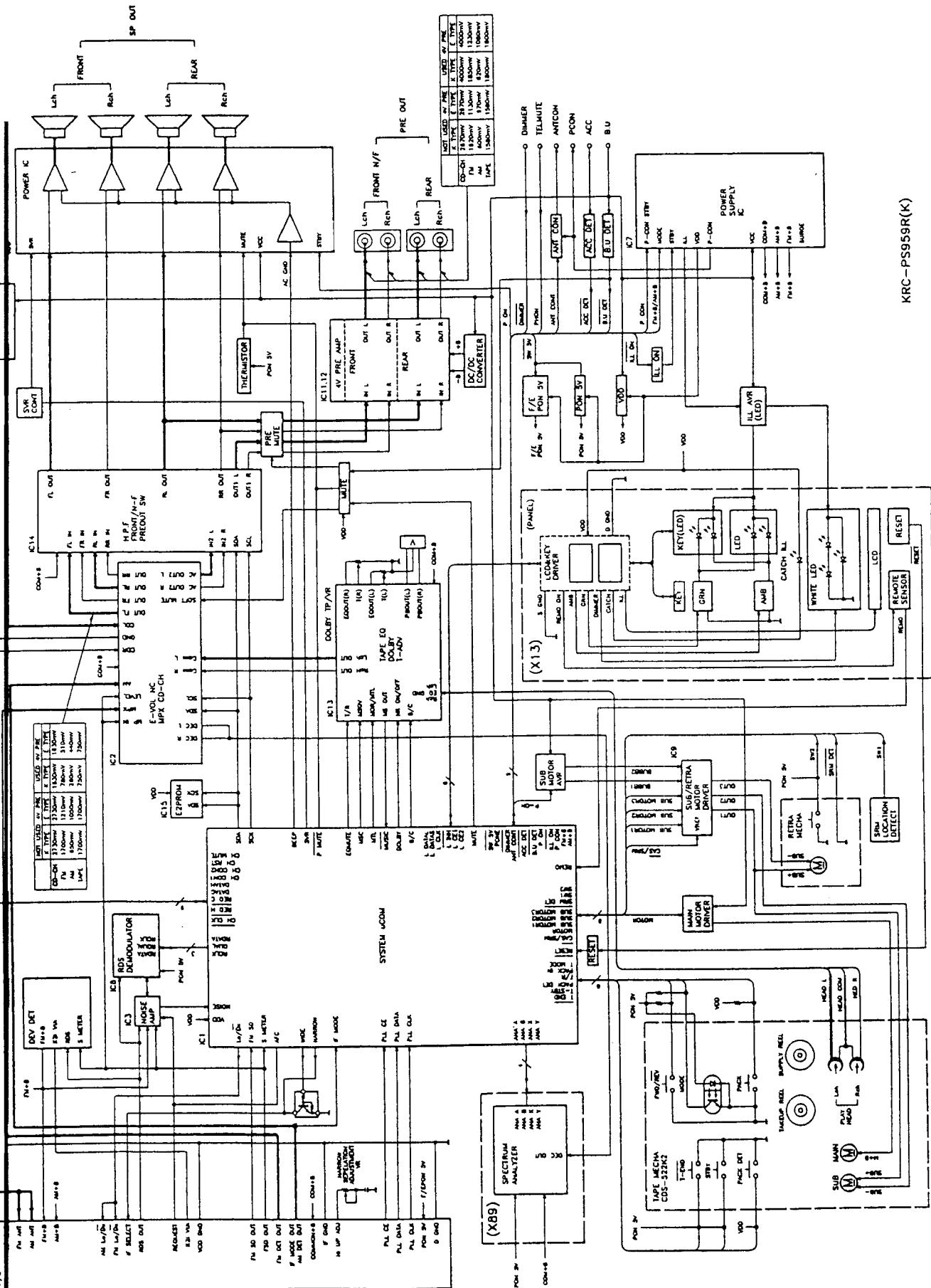

KRC-PS959R(K)

KRC-705/759R/R/785/805/859C  
/CY/R/R/RY/W/WY/885W/PS955

## COMPONENTS DESCRIPTION

SYNTHESIZER UNIT(X14-568X-XX)

Element	Application/Function	Operation/Conditions/Compatibility
IC1	Microprocessor system control	
IC2	E-VOL, NC, MPX	
IC3	Noise amplifier	
IC6	Power IC	
IC7	Power IC	
IC8	R.D.S. decoder	
IC9	C mechanism and housing mechanism sub-motor driver	
IC10	DC/DC converter	
IC11, 12	4V op amp	
IC13	T-EQ, T-ADV, Dolby	
IC14	H.P.F. selection, N/F selection	
IC15	EPROM	
IC16	Mute logic circuit	
IC18	DEV DET converter	
IC20	Reset IC	
Q1, 2, 3, 4	Pre-out mute	Mute at base "H".
Q10, 11	Music sensor detection constant selection	Base "H" during tape playback, base "L" in modes other than FF tape.
Q90	E-VOL IC mute	Mute at base "H".
Q121	Noise buffer	
Q122, 123	Noise detection output constant selection	Q123 base "L" during seek, "H" during reception.
Q139	Overmodulation detection	Base "H" during overmodulation.
Q140	Overmodulation detection	Base "H" during overmodulation.
Q141	Weak electric field	Base "L" when electric field is weak.
Q151	Sub-motor voltage switching	C mechanism voltage at base "L", SRM mechanism voltage at base "H".
Q199	SVR switch	Mute at base "H".
Q202, 204	P-ANT switch	P-ANT on at Q209 base "H".
Q205	Backup detection	Backup detection at base "H".
Q206	ACC detection	Acc detection at base "H".
Q207	B.V 5V AVR	5V on at base "H".
Q208	Pre-mute switch	Pre-mute on at base "L".
Q209	P-ON V5 AVR	On at base "L".
Q210	F/E P-ON 5V AVR	On at base "L".
Q211	Dimmer switch	Dimmer at base "H".
Q231	CH2 control switch	CH2 on at base "L".
Q241, 242	4V op amp 10V AVR	On at base "H".
Q243, 244	10V AVR switch	On at base "H".
Q245 - 250	Plus-minus differential stabilizing circuit	
Q301, 302	Main motor AVR	AVR on at Q302 base "H".
Q303, Q305	LED AVR	AVR on at Q305 base "H".
Q304, Q307	Sub-motor driver AVR	AVR on at Q307 base "H".
Q306, Q308	Sub-motor driver AVR switch	AVR on at Q308 base "H".
Q311	Reset switch	Reset at base "H".
Q323	FM LO/DX switch	DX at base "H", LO at base "L".
Q324	Forced wide switch	Base "H" at forced wide.

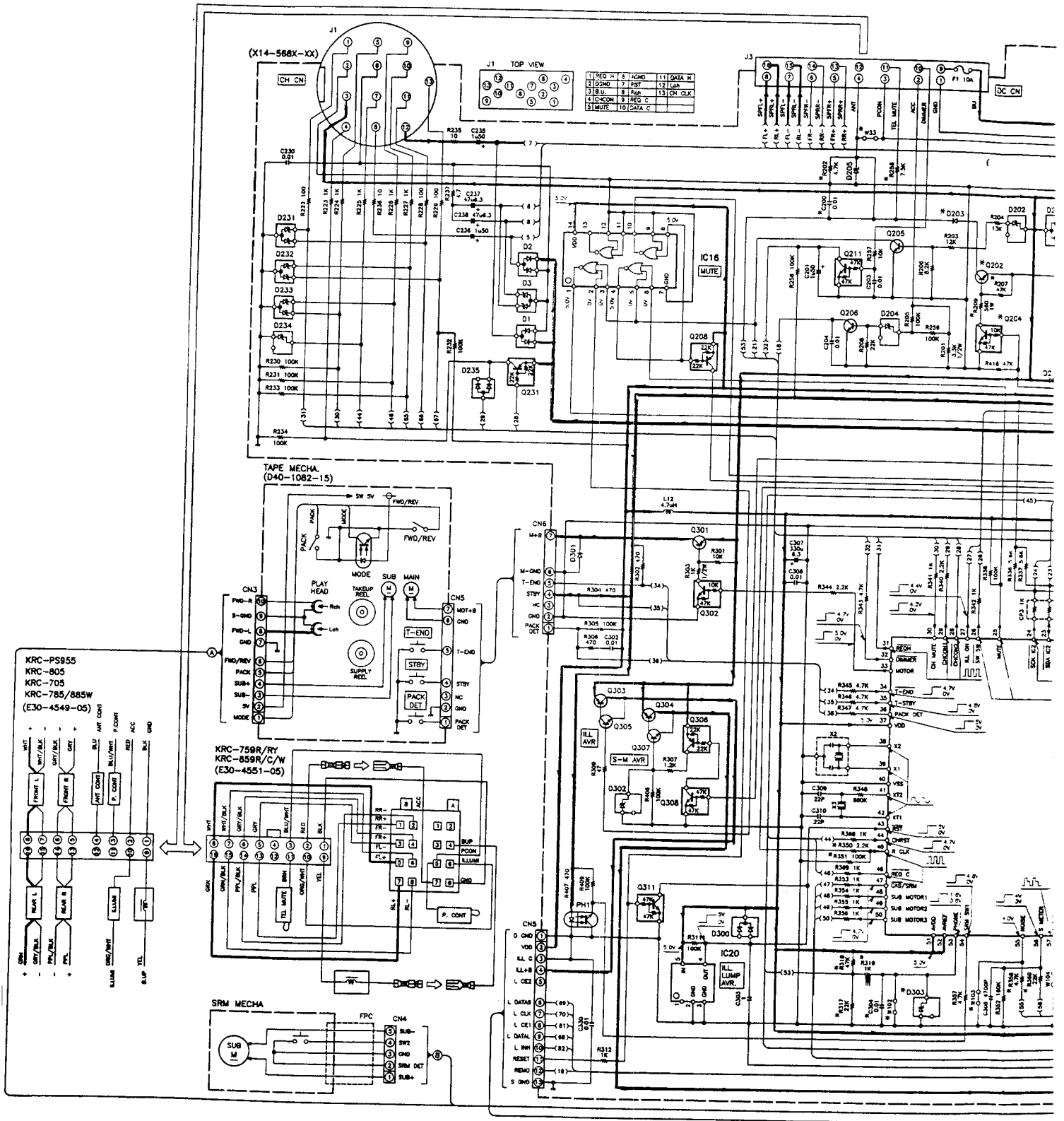

KRC-P5855  
 KRC-805  
 KRC-705  
 KRC-785/885W  
 (E30-4549-05)

KRC-758R/RY  
 KRC-859R/C/W  
 (E30-4551-05)



2SB1184

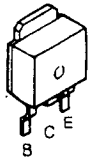

2SB1277  
2SB1443

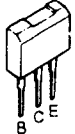

2SA1037K

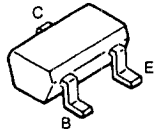

BA6238A

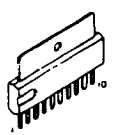

NJM2903M  
NJM4565M-TE2

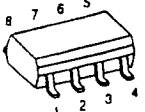

DAN202

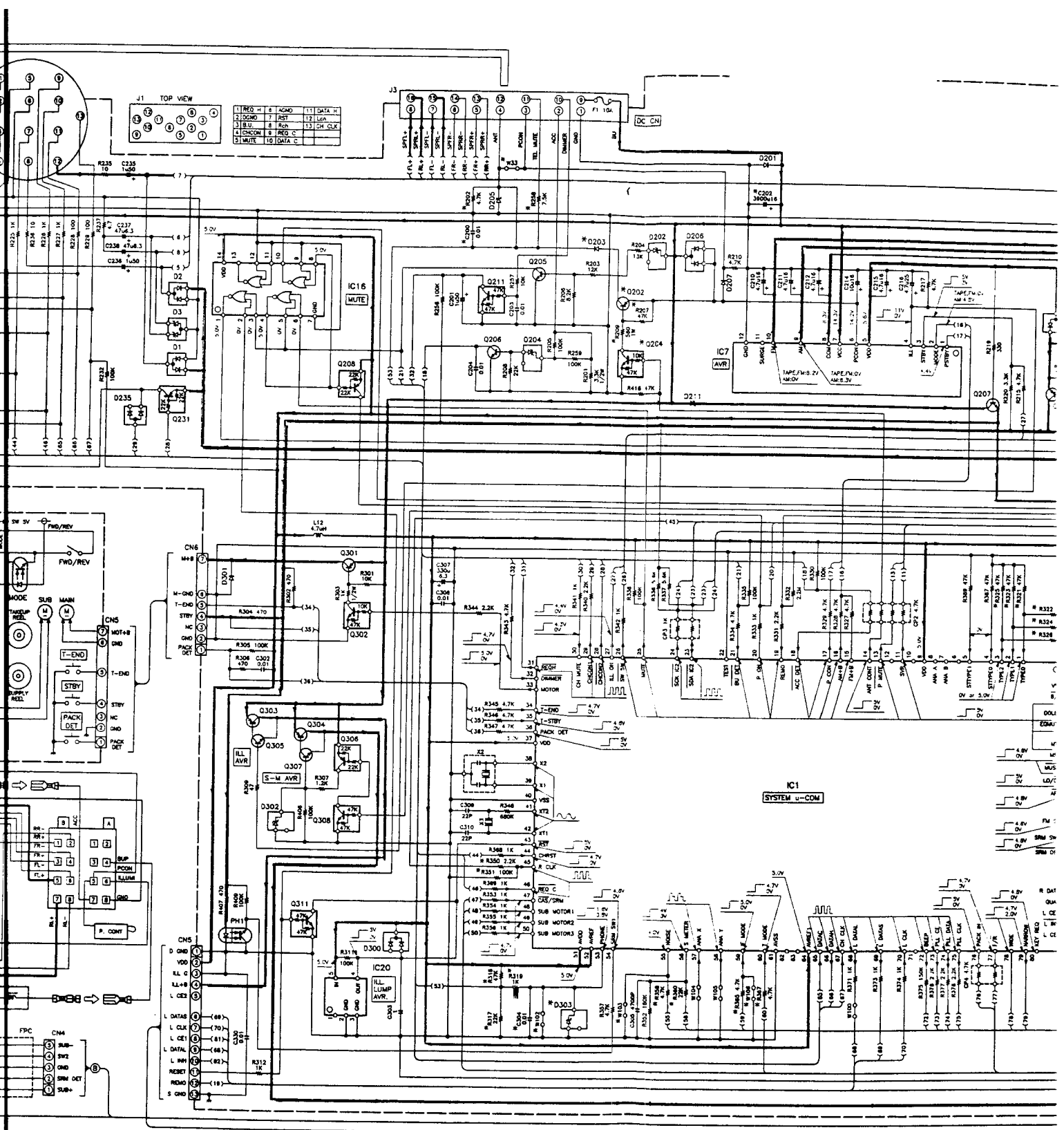

1	REG	4	AGND	11	DATA
2	DGMO	7	RST	12	LCA
3	B.U	8	Rch	13	CH CLK
4	L.FUNCTION	9	REG C		
5	MUTE	10	DATA C		

2SB1277  
2SB1443

2SA1037K

BA6238A

NJM2903M  
NJM4565M-TE2

DAN202K

DA204K

RD6.8M

TC

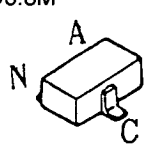
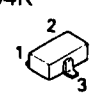
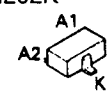
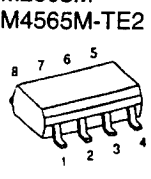
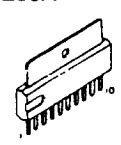
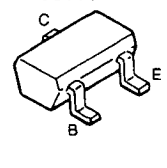
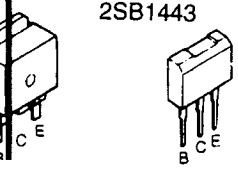

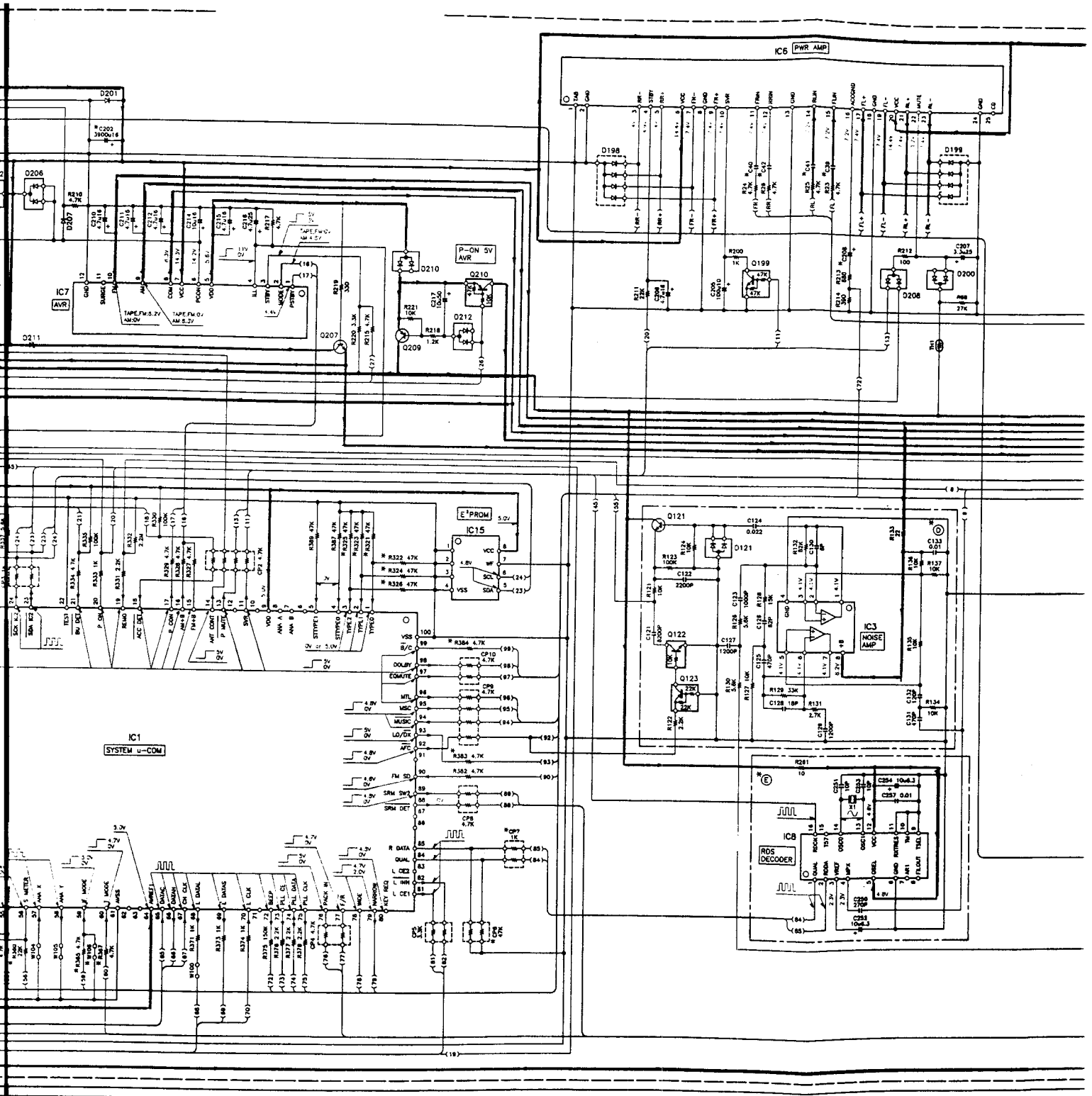

- W202K

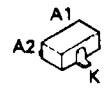

- DA204K

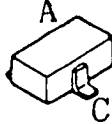

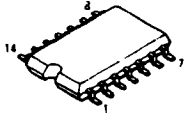
- RD6.8M

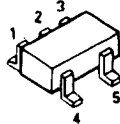
- TC74HC02AF

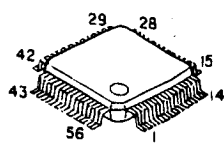
- PST9130NR

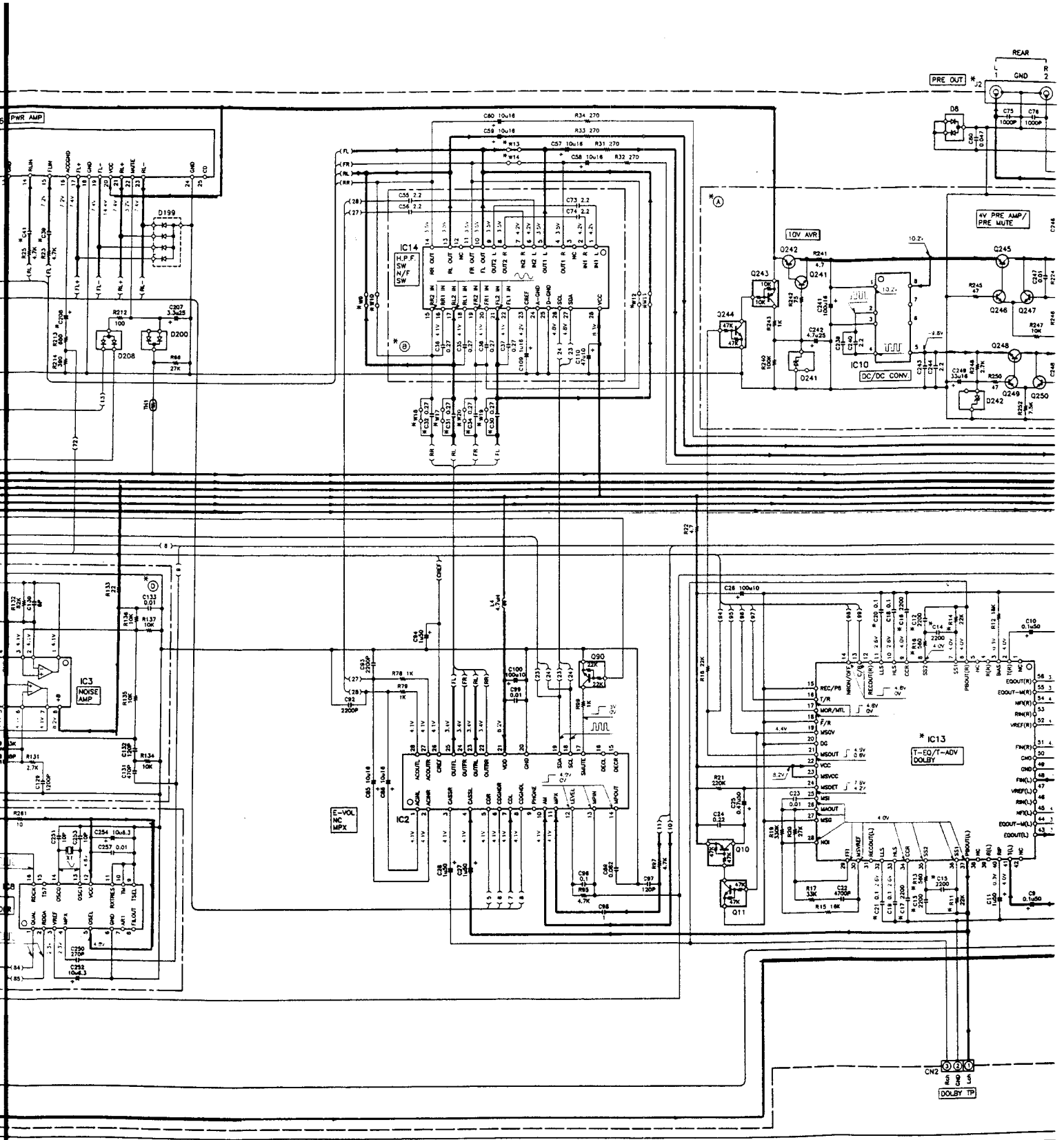

- HA12163FP



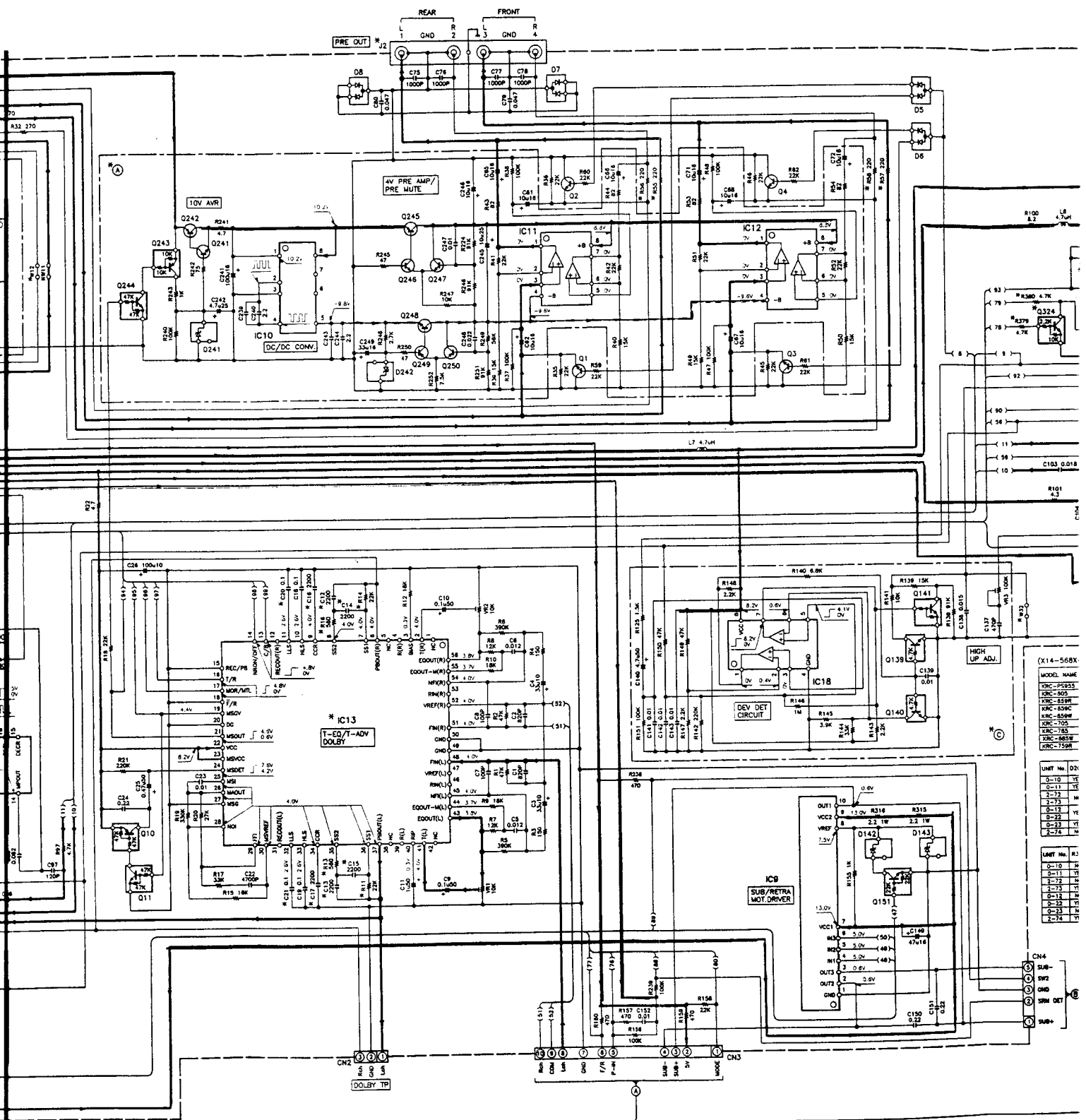

DC voltages are as measured with a high impedance voltmeter. Values may vary slightly due to variations between individual instruments or/and units.

**CAUTION:** For continued safety, replace components only with manufacturer's recom (refer to, parts list).  $\Delta$  Indicates safety critica To reduce the risk of electric shock, leakage resistance measurements shall be carried out are acceptably insulated from the supply circ appliance is returned to the customer.



(X14-568X)

MODEL NAME	UNIT No. D21	UNIT No. R1
KRC-PS955	0-10	0-10
KRC-605	0-11	0-11
KRC-639	2-12	2-12
KRC-639R	2-13	2-13
KRC-659C	0-12	0-12
KRC-659R	0-23	0-23
KRC-705	KRC-685R	0-24
KRC-685R	2-14	2-14

ance voltmeter.  
 ven individual

**CAUTION:** For continued safety, replace safety critical components only with manufacturer's recommended parts (refer to, parts list).  $\Delta$  Indicates safety critical components. To reduce the risk of electric shock, leakage-current or resistance measurements shall be carried out (exposed parts are acceptably insulated from the supply circuit) before the appliance is returned to the customer.



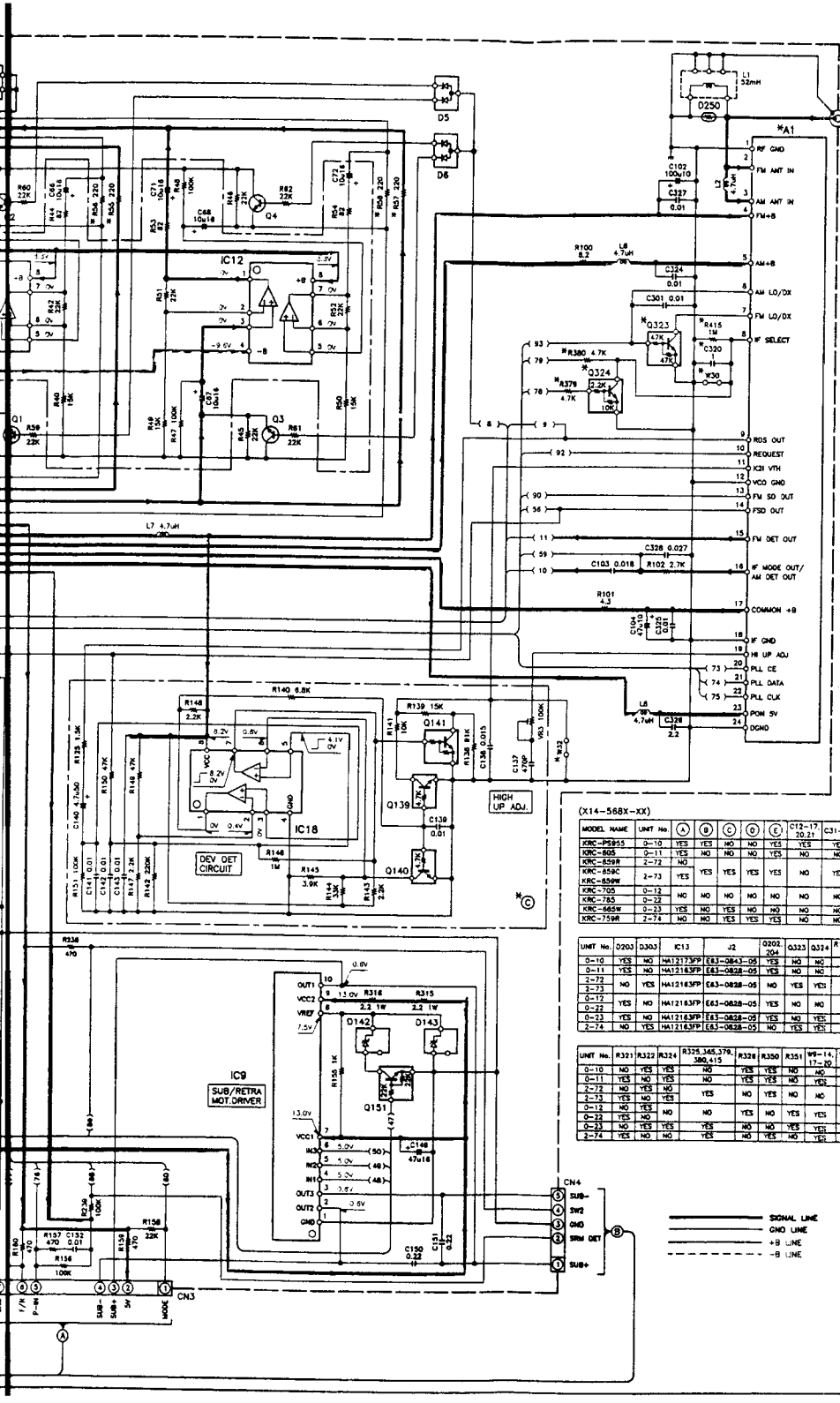

- IC1 : UPD784215GF522
- IC2 : TDA7451D
- IC3,11,12 : NUM4555M-TE2
- IC6 : TDA7386
- IC7 : BA3917-V4
- IC8 : TDA7479D
- IC9 : BA6238A
- IC10 : TC7660SEGA
- IC14 : TDA7435
- IC15 : KK206F
- IC16 : TC74HC02AF
- IC18 : NUM2903M
- IC20 : PST9130NR
- Q1-4 : 2SD114K
- Q10 : DTA144EK
- Q11,199,211,244,308,311,323,090,151 : DTC144EK
- Q121,205,206,241,248-249,305,307 : DTC124EK
- Q122 : 2SC2412K
- Q123,208,231,308 : DTC114YK
- Q139,140 : DTA124EK
- Q141 : DTC143TK
- Q202 : DTC124TK
- Q202,302 : 2SB1277(Q,R)
- Q207 : DTC114YK
- Q208,245,249,250 : 2SD1760
- Q210 : 2S4103TK
- Q242,301,304 : DTA114YK
- Q243 : 2SB1443
- Q303 : DTA114EK
- Q324 : 2SB1184
- Q324 : DTD123TK
- D1,2,7,8 : DA204K
- D3,231-233 : MA3062WA
- D5,6,121,208,212,235 : DAP202K
- D142 : MA3066-M
- D143 : MA3075-M
- D198,199 : DCA80R
- D200,206,300 : DAN202K
- D201 : RM102LF
- D202,204 : R06.5M(B2)
- D203,207,211,301 : AM01Z
- D205 : M1F60
- D210 : 1SS181
- D234 : MA3082-M
- D241 : H2M11N(B1)
- D242 : MA3056-M
- D250 : DS9-301M-A21F
- Q302 : H2M22M(B3)
- Q303 : MA3047-M

(X14-568X-XX)

MODEL NAME	UMF No	(A)	(B)	(C)	(D)	C12-17	C200	C202	C208	CP8	CP7	
KRC-PS815	0-10	YES	NO	NO	YES	YES	0.22	NO	C90-2854-05	1	NO	YES
KRC-805	0-11	YES	NO	NO	NO	NO	0.12	NO	C90-2854-05	0.47	NO	YES
KRC-859R	2-72	NO	NO	NO	NO	NO	0.12	NO	C90-2854-05	0.47	NO	YES
KRC-859C	2-73	YES	YES	YES	YES	NO	0.22	YES	C90-2854-05	1	YES	NO
KRC-859W	2-74	YES	YES	YES	YES	NO	0.12	NO	C90-2854-05	0.47	YES	NO
KRC-705	0-12	NO	NO	NO	NO	NO	0.12	NO	C90-2854-05	0.47	YES	NO
KRC-785	0-22	YES	YES	YES	YES	NO	0.12	NO	C90-2854-05	0.47	YES	NO
KRC-885W	0-23	YES	NO	YES	NO	NO	0.12	NO	C90-2854-05	0.47	YES	NO
KRC-759R	2-74	NO	NO	YES	YES	NO	0.12	YES	C90-2854-05	0.47	YES	NO

UMF No	D200	D300	IC11	J2	Q202	Q323	Q334	R11	R13,14	R55-56	R007,207	R256,317-319
0-10	YES	NO	HA12173FP	EA3-0843-05	YES	NO	NO	YES	NO	NO	YES	NO
0-11	YES	NO	HA12163FP	EA3-0828-05	YES	NO	NO	NO	NO	NO	YES	NO
2-72	NO	YES	HA12163FP	EA3-0828-05	NO	YES	YES	NO	NO	NO	NO	YES
2-73	NO	YES	HA12163FP	EA3-0828-05	NO	YES	YES	NO	NO	NO	NO	YES
0-12	YES	NO	HA12163FP	EA3-0828-05	YES	NO	NO	NO	NO	NO	YES	NO
0-23	YES	NO	HA12163FP	EA3-0828-05	YES	NO	YES	NO	NO	NO	YES	NO
2-74	NO	YES	HA12163FP	EA3-0828-05	NO	YES	YES	NO	NO	NO	YES	NO

UMF No	R321	R322	R324	R325,365,370,380,415	R328	R330	R351	W8-14	W30,32,108	W33	W102	A1
0-10	NO	YES	YES	YES	YES	NO	NO	NO	NO	NO	YES	W02-3118-05
0-11	YES	NO	YES	NO	YES	YES	NO	NO	YES	NO	NO	W02-3118-05
2-72	NO	YES	NO	NO	YES	NO	NO	NO	NO	NO	NO	W02-3118-05
2-73	YES	NO	YES	NO	NO	NO	NO	NO	NO	NO	NO	W02-3118-05
0-12	YES	NO	NO	NO	YES	NO	NO	NO	NO	NO	NO	W02-3123-05
0-22	YES	NO	NO	NO	YES	NO	YES	YES	YES	NO	NO	W02-3118-05
0-23	NO	YES	YES	YES	NO	NO	NO	NO	NO	NO	NO	W02-3123-05
2-74	YES	NO	NO	NO	NO	YES	NO	NO	NO	YES	NO	W02-3123-05

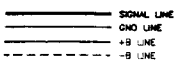

X13-CM1  
2/2  
C

# KRC-705/759R/R/RY/785/805/859C /CY/R/RY/W/WY/885W/PS955



(X13-9140-10)

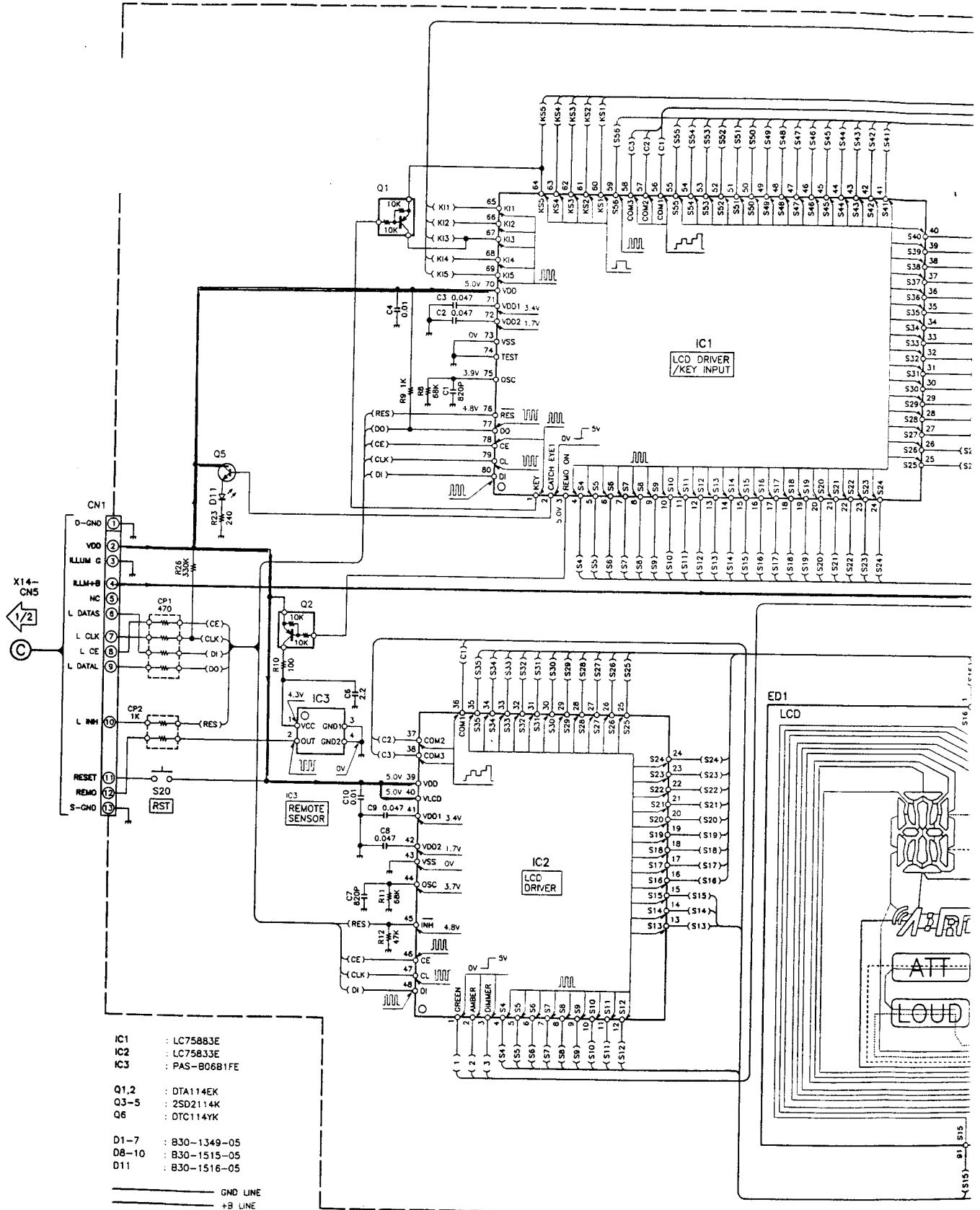

DC voltages are as measured with a high impedance voltmeter. Values may vary slightly due to variations between individual instruments or/and units

**CAUTION:** For continued safety, replace safety critical components only with manufacturer's recommended parts (refer to, parts list).  $\Delta$  Indicates safety critical components. To reduce the risk of electric shock, leakage-current or resistance measurements shall be carried out (exposed parts are acceptably insulated from the supply circuit) before the appliance is returned to the customer.

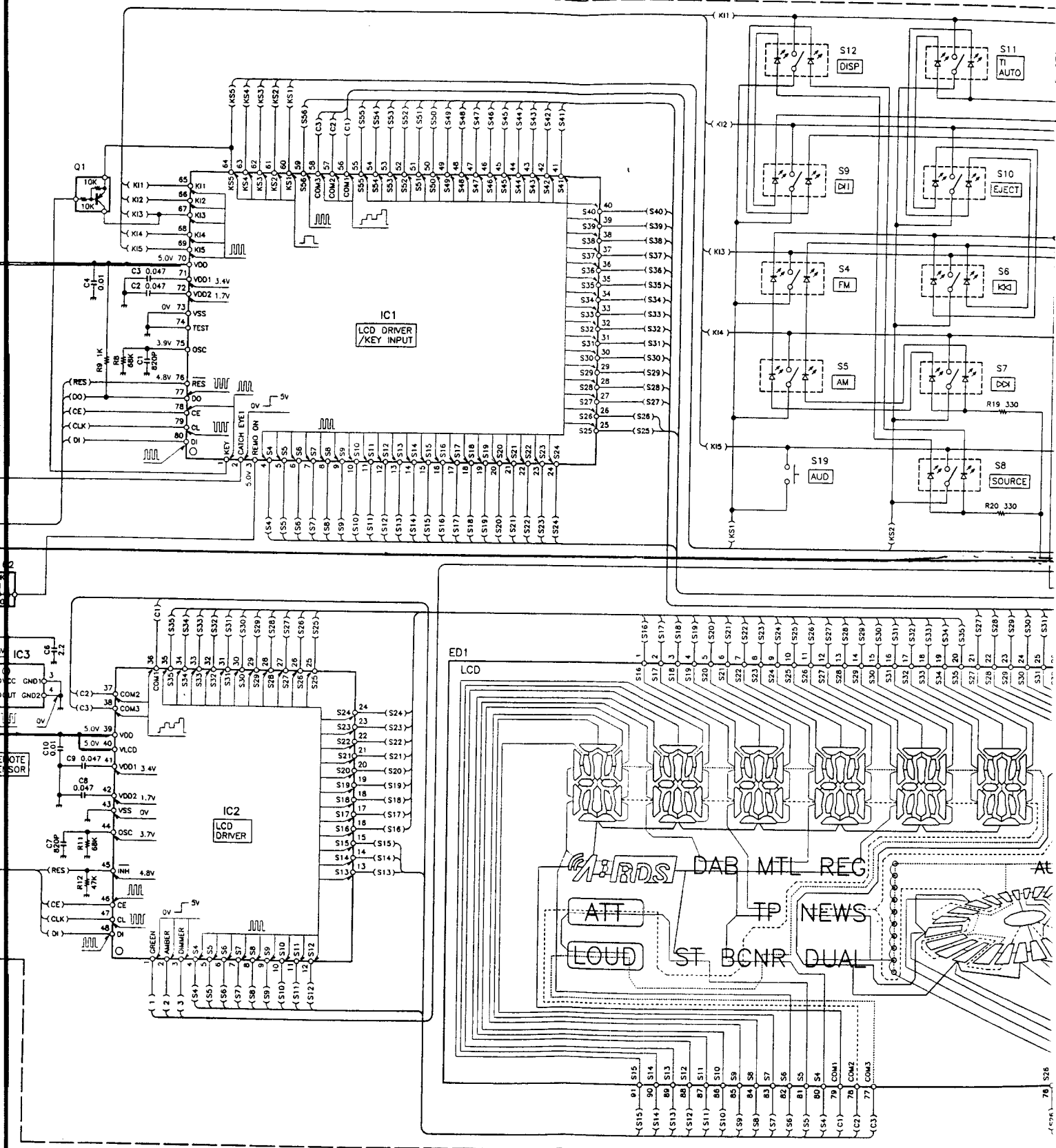

high impedance voltmeter.  
connections between individual

**CAUTION:** For continued safety, replace safety critical components only with manufacturer's recommended parts (refer to, parts list).  $\Delta$  Indicates safety critical components. To reduce the risk of electric shock, leakage-current or resistance measurements shall be carried out (exposed parts are acceptably insulated from the supply circuit) before the appliance is returned to the customer.

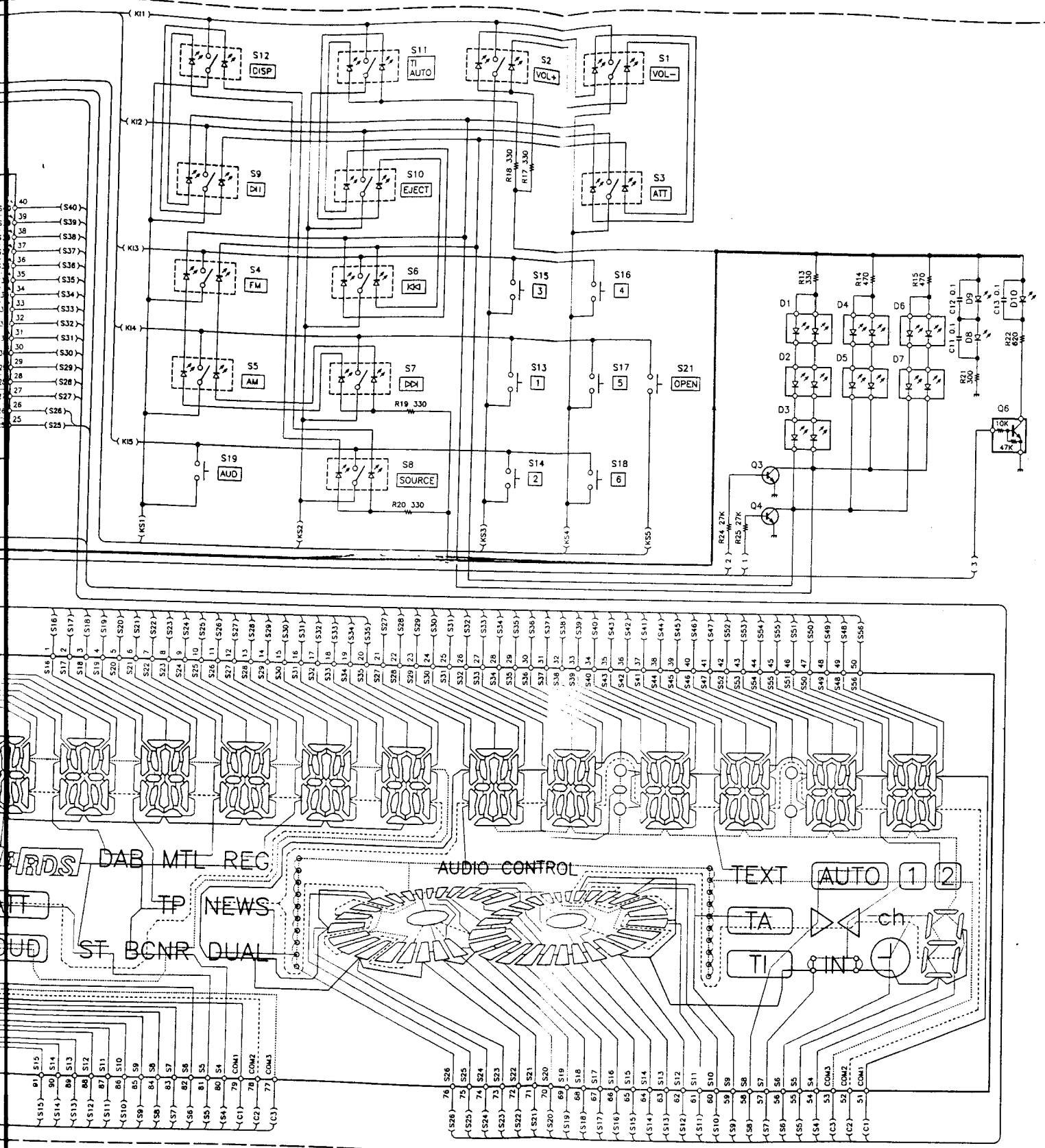

KRC-705/759R/Ry/785/805/859C  
/CY/R/Ry/W/Wy/885W/PS955

KRC-705/759R/RY/785/805/859C  
/CY/R/RY/W/WY/885W/PS955

EXPLODED VIEW (MECHANISM)

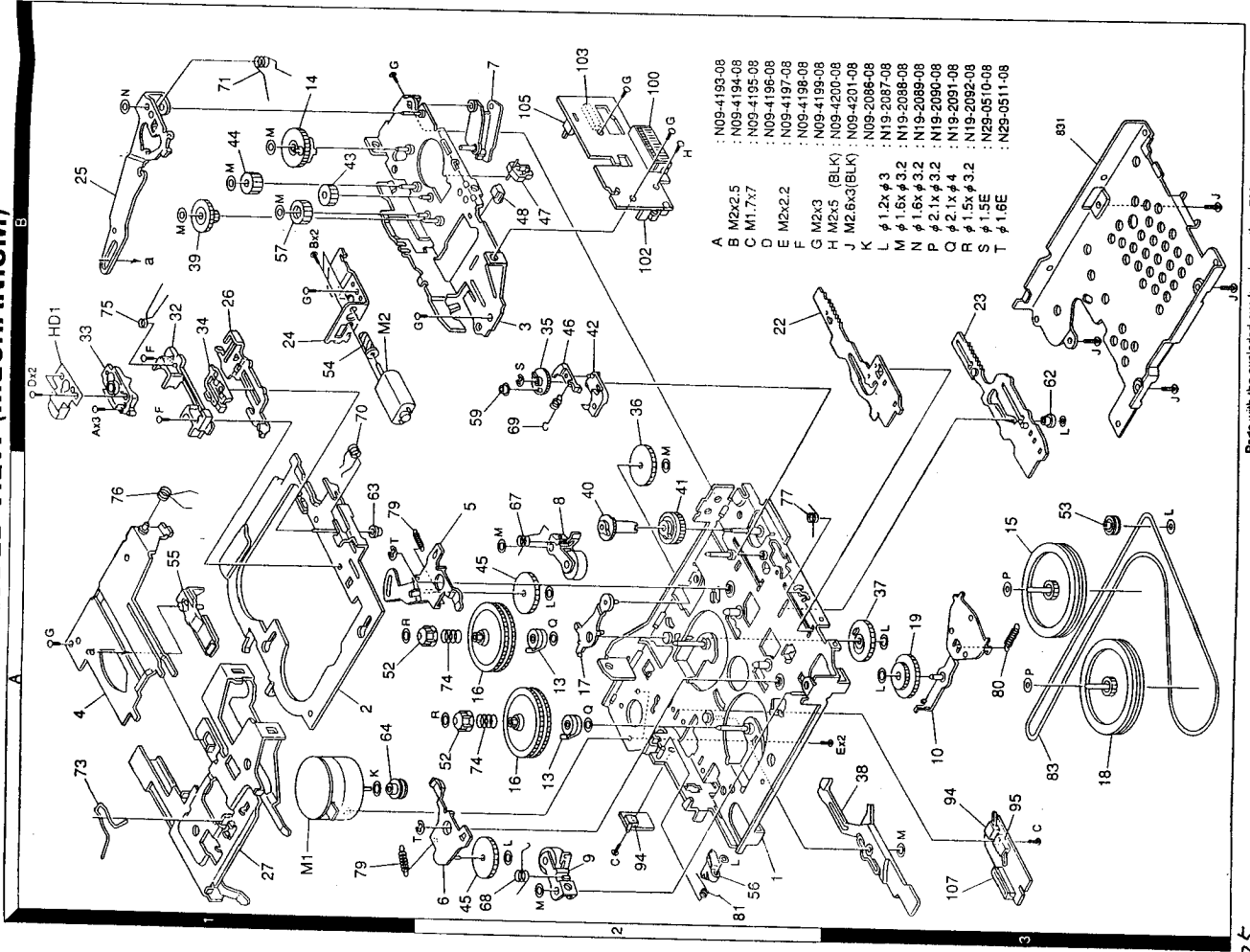

KRC-705/759R/RY/785/805/859C  
/CY/R/RY/W/WY/885W/PS955

EXPLODED VIEW (MAIN)

